

# Ultra Compact 35mm Camera Waterproof Casing (reloading film and flash use)

1 2 3 4 5 6 7 8 9 10 11 12 13 14 15 16 17

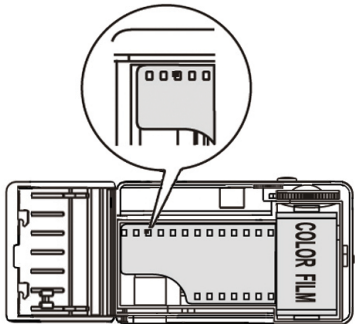

1 2 3 4 5 6 7 8 9 10 11 12 13 14 15 16 17

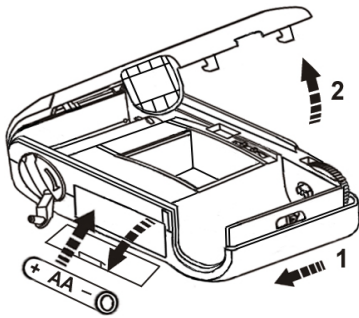
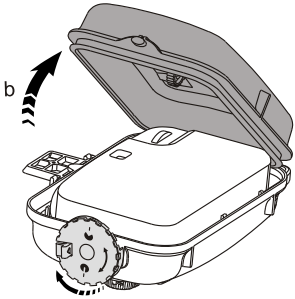
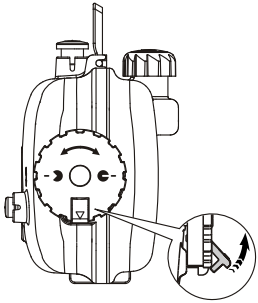
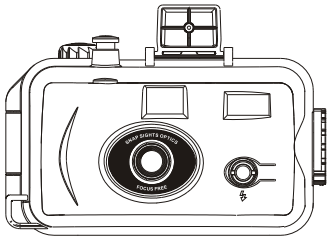
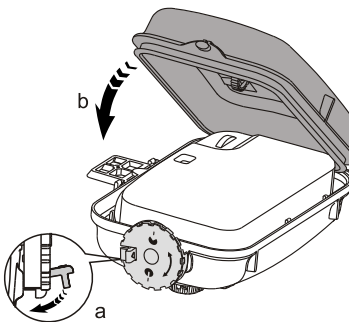
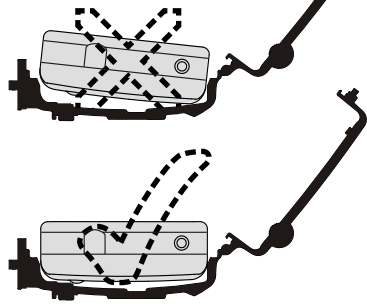
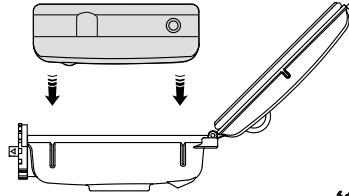
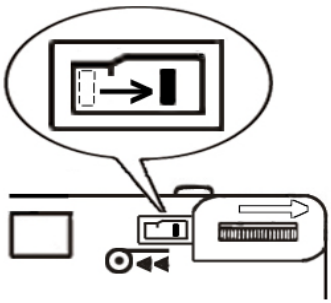
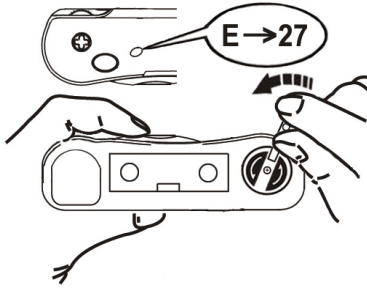
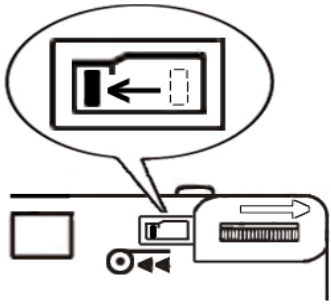

1 2 3 4 5 6 7 8 9 10 11 12 13 14 15 16 17

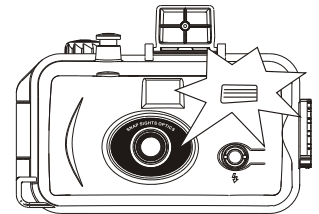
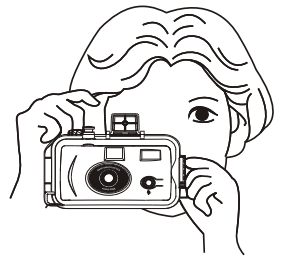
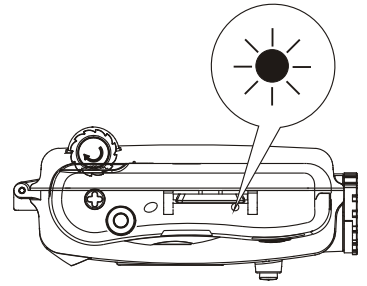
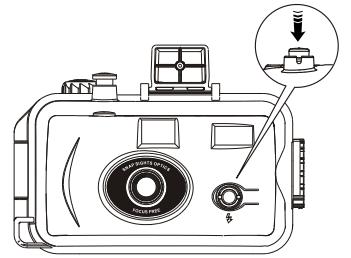
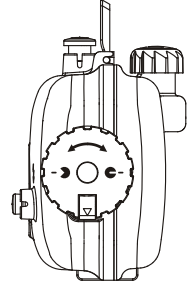
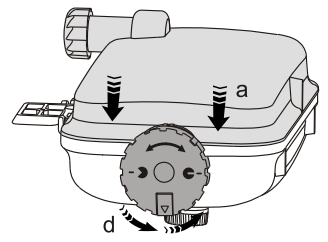

1 2 3 4 5 6 7 8 9 10 11 12 13 14 15 16 17